

Model S3-2

Order Verification Form

CUSTOMER.

VERIFICATION MUST BE RECEIVED BEFORE
ORDER CAN BE ENTERED FOR SHIPMENT.

PLEASE SIGN TO VERIFY
S3-2 FT. BURY
MEETS YOUR REQUIREMENTS.

Customer Signature

Please print name and return to
Woodford Mfg. FAX: 800-765-4115

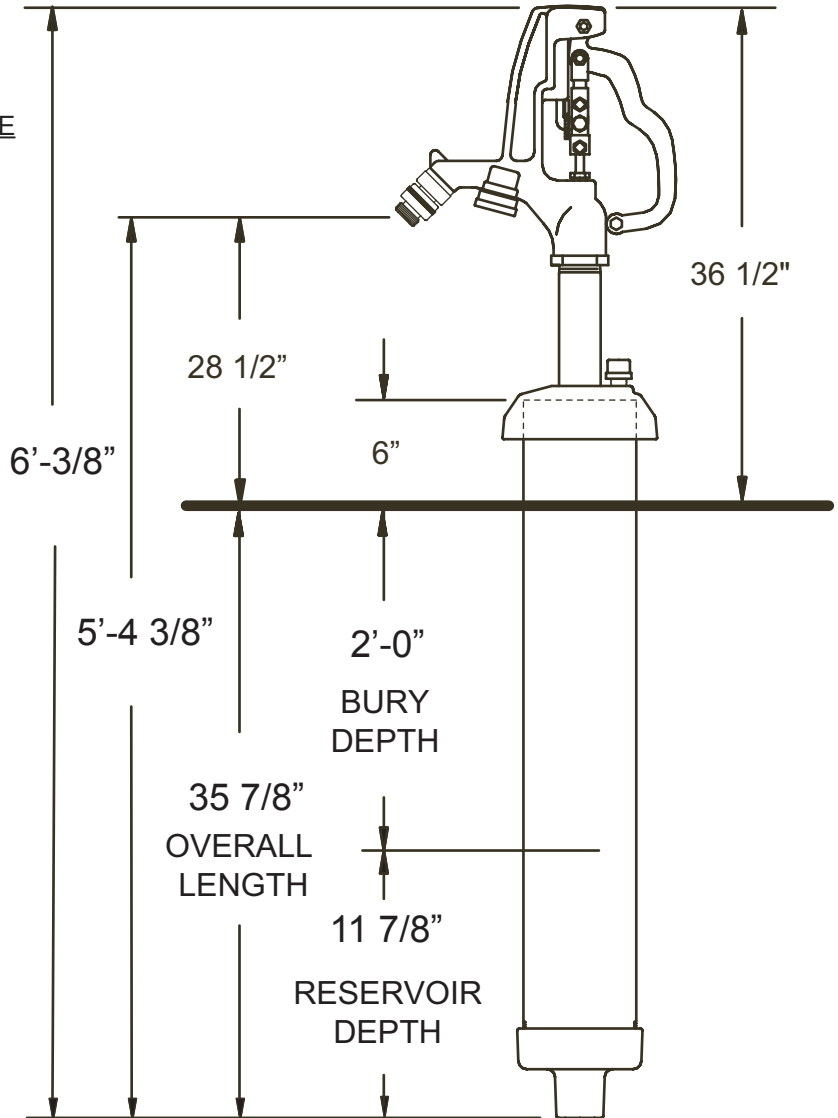

WOODFORD MANUFACTURING COMPANY, LLC.

2121 Waynoka Road, Colorado Springs, Colorado 80915 • Phone: (800) 621-6032 • Fax: (800) 765-4115
To view our complete product line visit: www.woodfordmfg.com or email: sales@woodfordmfg.com