

# Model S3-3

## Order Verification Form

CUSTOMER,

VERIFICATION MUST BE RECEIVED BEFORE  
ORDER CAN BE ENTERED FOR SHIPMENT.

PLEASE SIGN TO VERIFY  
S3-3FT. BURY  
MEETS YOUR REQUIREMENTS.

\_\_\_\_\_  
Customer Signature

\_\_\_\_\_  
Please print name and return to  
Woodford Mfg. FAX: 800-765-4115

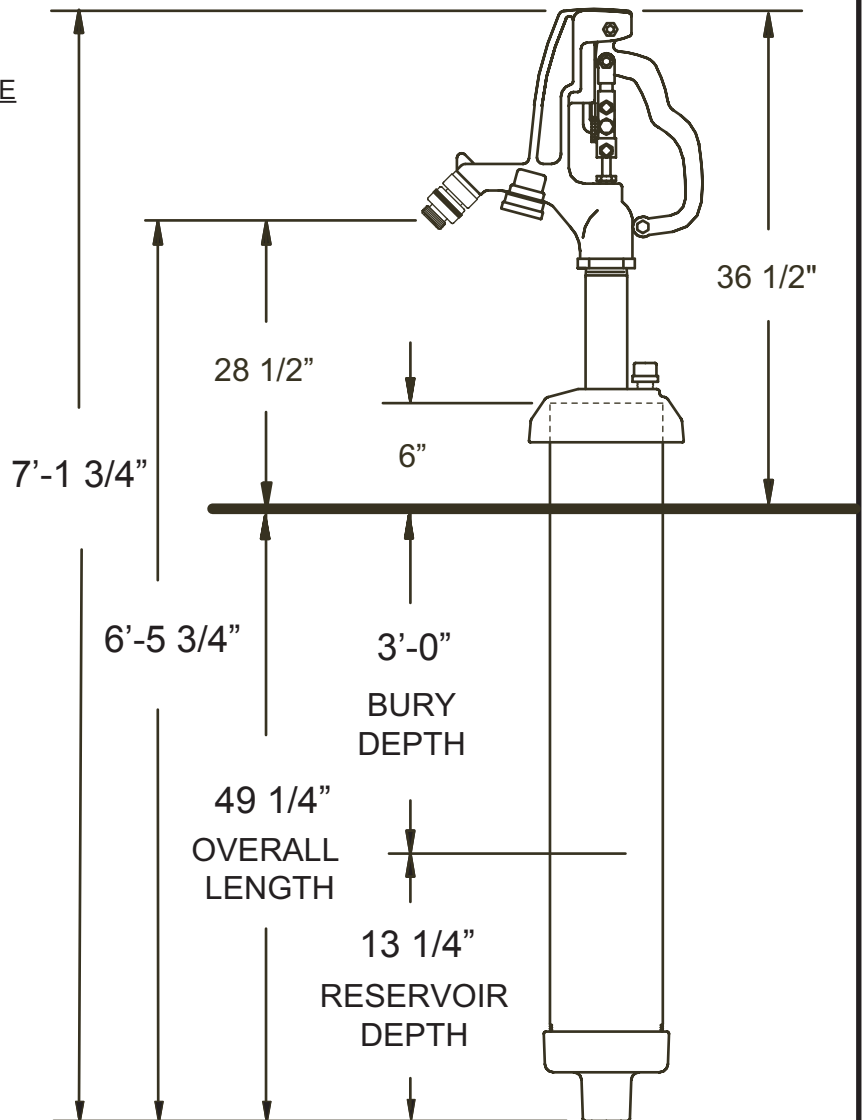

**WOODFORD MANUFACTURING COMPANY**

Sales Office:

2121 Waynoka Road, Colorado Springs, Colorado 80915

Phone:

(800) 621-6032

Fax: (800) 765-4115