



ADA Compliant
Self-Closing

Model S4H-7

Order Verification Form

SIDE MOUNT HANDLE

CUSTOMER.

VERIFICATION MUST BE RECEIVED BEFORE
ORDER CAN BE ENTERED FOR SHIPMENT.

PLEASE SIGN TO VERIFY
S4H-7FT. BURY
MEETS YOUR REQUIREMENTS.

Customer Signature

Please print name and return to
Woodford Mfg. FAX: 800-765-4115

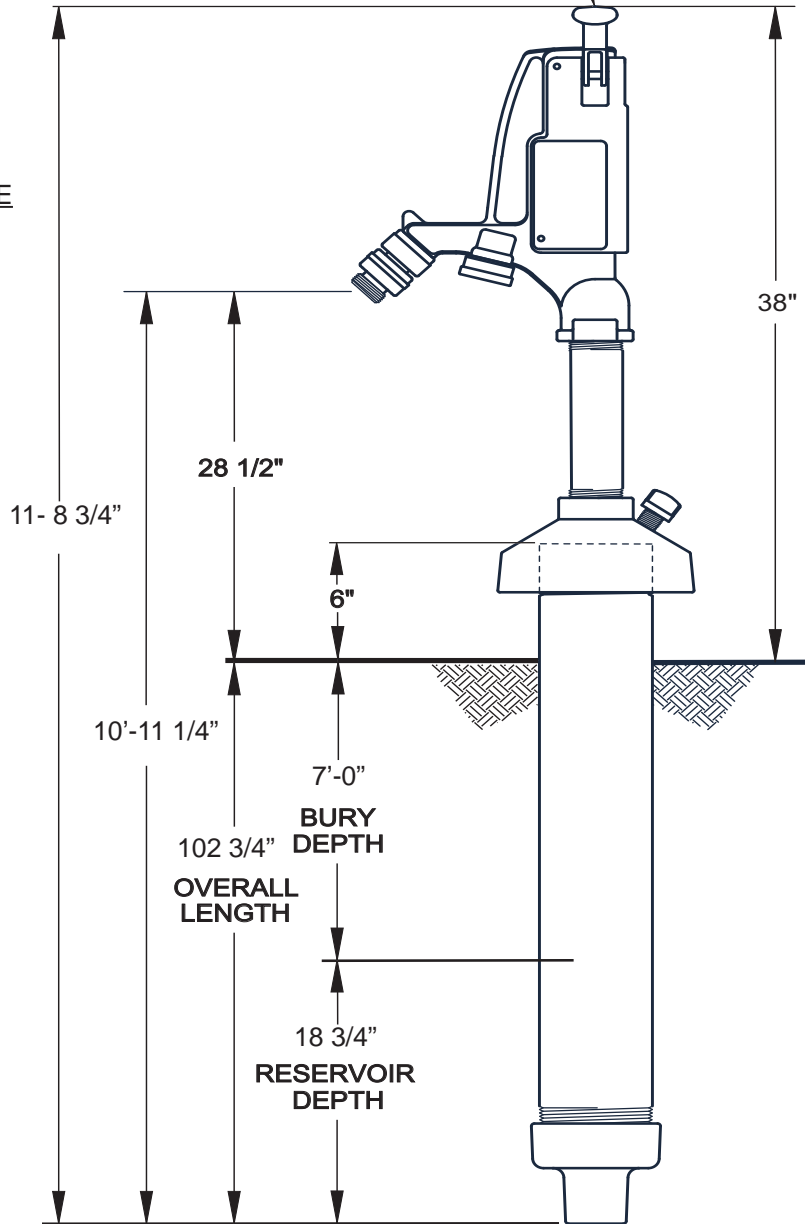

WOODFORD MANUFACTURING COMPANY

Sales Office:

2121 Waynoka Road, Colorado Springs, Colorado 80915

Phone:

(800) 621-6032

Fax: (800) 765-4115